

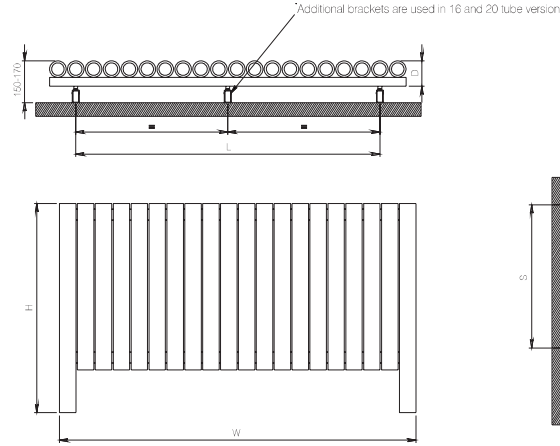

fortuna

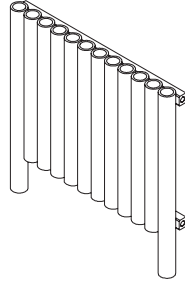

material	finish	electric version	wall installation	warranty
stainless steel	satın polished	1200 W	floor standing	10 years

max. working pressure: 10 bar
 max. working temperature: 95°C
 all dimensions are in mm.
 connections 1/2"

Product Code	Width	Height	Depth	Connection Centers	Tube Quantity	Assembly Axis		Weight	Water Capacity	THERMAL POWER		
	W	H	D	C		S	L	kg.	lt.	btu	k/cal	watt
FOR051506000809	515	600	102	515	8	360	390	18	4,5	3799	957	1113
FOR064506001009	645	600	102	645	10	360	520	22,2	5,7	4679	1178	1370
FOR077506001209	775	600	102	775	12	360	650	26,4	6,8	5558	1400	1628
FOR090506001409	905	600	102	905	14	360	780	30,6	8	6437	1621	1885
FOR103506001609	1035	600	102	1035	16	360	845	34,8	9,1	7317	1843	2143
FOR129506002009	1295	600	102	1295	20	360	1105	43,3	11,4	9075	2285	2658
FOR051507600809	515	760	102	515	8	520	390	23,3	5,5	4942	1245	1447
FOR064507601009	645	760	102	645	10	520	520	28,7	6,9	6107	1538	1788
FOR077507601209	775	760	102	775	12	520	650	34,1	8,2	7272	1831	2129
FOR090507601409	905	760	102	905	14	520	780	39,5	9,6	8437	2125	2471
FOR103507601609	1035	760	102	1035	16	520	845	45,4	11	9602	2418	2812
FOR129507602009	1295	760	102	1295	20	520	1105	51,6	13,8	11932	3005	3494

FORTUNA

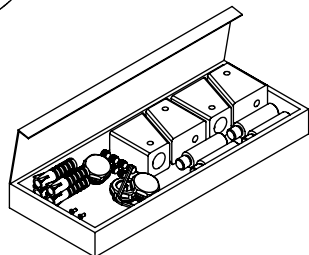
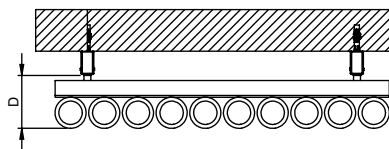
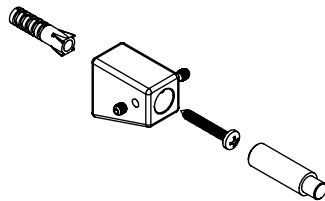
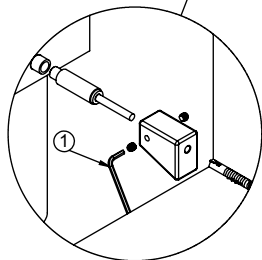
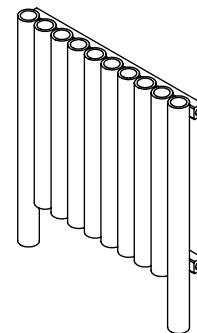
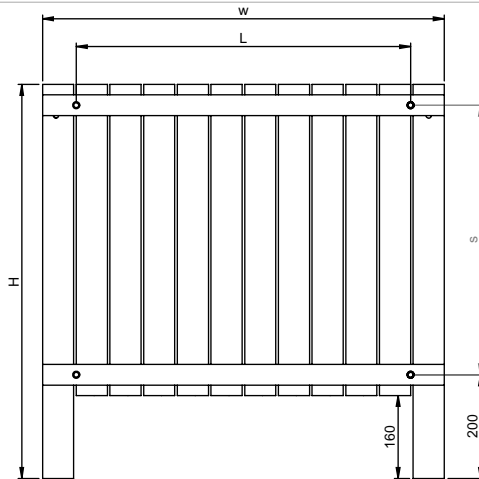
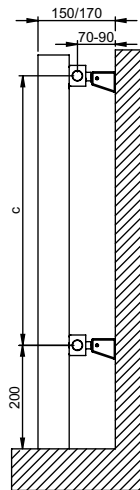
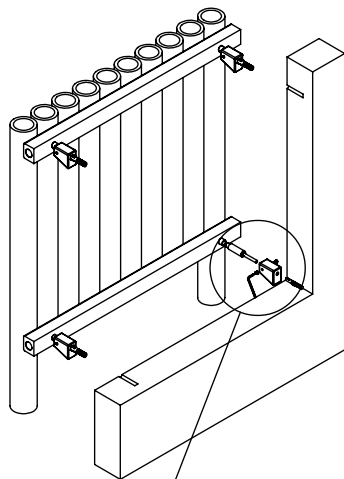

Product Code	Width	Height	Depth	Connection Centers	Tube Quantity	Assembly Axis		Weight	Water Capacity
	W	H	D	C	S	L	kg.	lt.	
FOR051506000809	515	600	102	515	8	360	390	18	4.5
FOR064506001009	645	600	102	645	10	360	520	22.2	5.7
FOR077506001209	775	600	102	775	12	360	650	26.4	6.8
FOR090506001409	905	600	102	905	14	360	780	30.6	8
FOR103506001609	1035	600	102	1035	16	360	845	34.8	9.1
FOR129506002009	1295	600	102	1295	20	360	1105	43.3	11.4
FOR051507600809	515	760	102	515	8	520	390	51.6	5.5
FOR064507601009	645	760	102	645	10	520	520	23.3	6.9
FOR077507601209	775	760	102	775	12	520	650	28.7	8.2
FOR090507601409	905	760	102	905	14	520	780	34.1	9.6
FOR103507601609	1035	760	102	1035	16	520	845	39.5	11
FOR129507602009	1295	760	102	1295	20	520	1105	45.4	13.8