

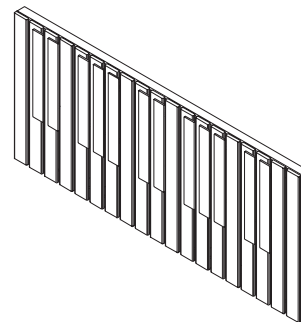

**piano**

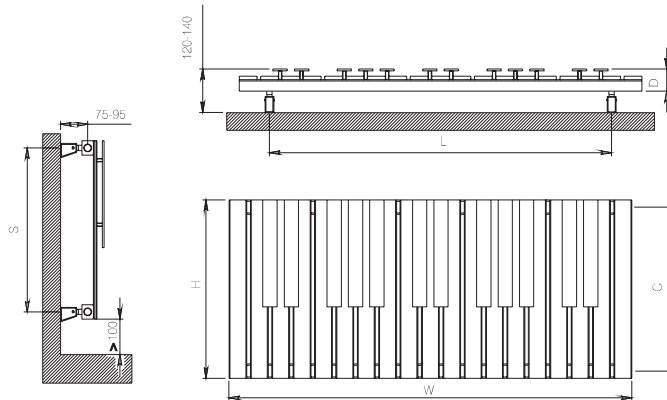

material	finish	electric version	wall installation	warranty
stainless steel	satın polished	1200 W	horizontal vertical	10 years

max. working pressure: 10 bar  
 max. working temperature: 95°C  
 all dimensions are in mm.  
 connections 1/2"

Product Code	Width	Height	Depth	Connection Centers	Tube Quantity	Assembly Axis		Weight	Water Capacity	THERMAL POWER		
	W	H	D	C		S	L	kg.	lt.	btu	k/cal	watt
PIA113005001909	1130	500	67	460	19	460	960	24,1	5,3	3488	879	1022
PIA113006001909	1130	600	67	560	19	560	960	27,7	5,9	4051	1021	1187

# PIANO

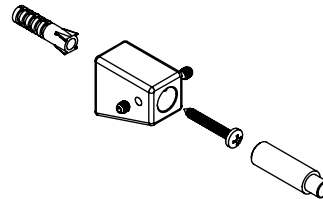
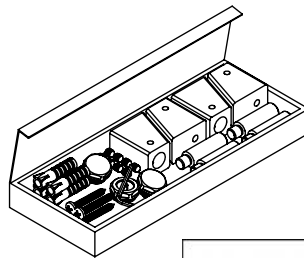
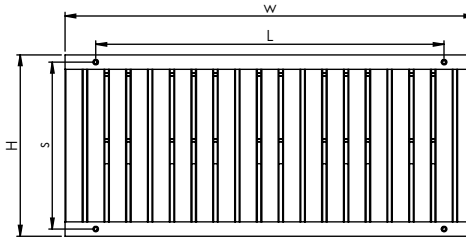
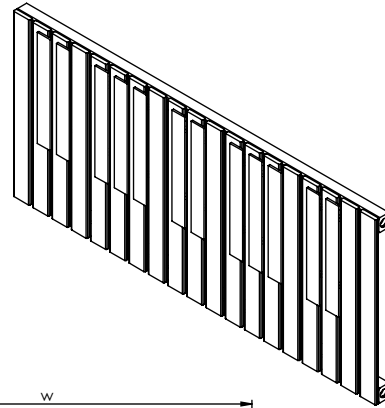
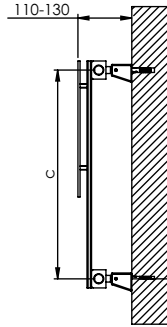
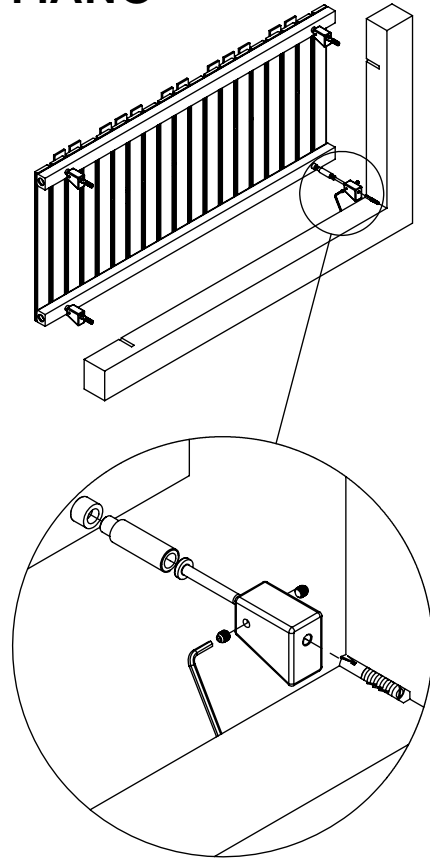

Product Code	Width	Height	Depth	Connection Centers	Tube Quantity	Assembly Axis		Weight	Water Capacity
	W	H	D	C		S	L	kg.	lt.
PIA113005001909	1130	500	67	460	19	460	960	24,1	5,3
PIA113006001909	1130	600	67	560	19	560	960	27,7	5,9