

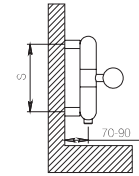

**swing**

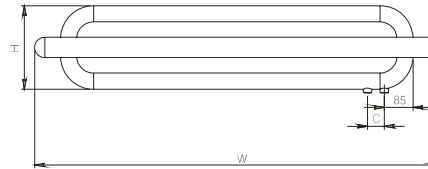

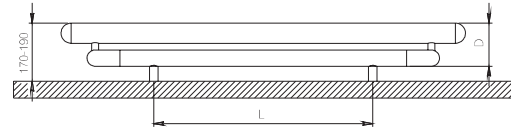

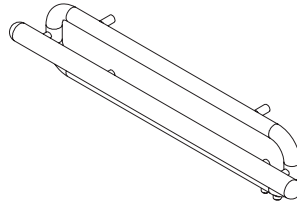

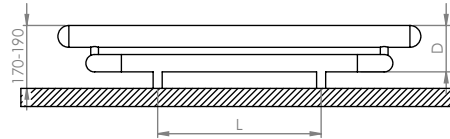
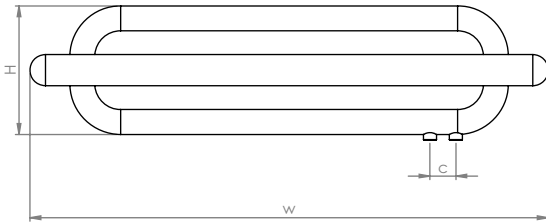
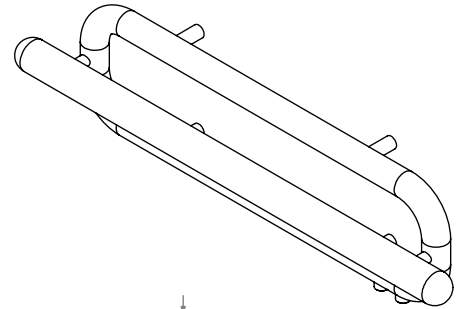
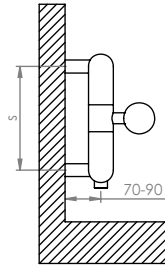
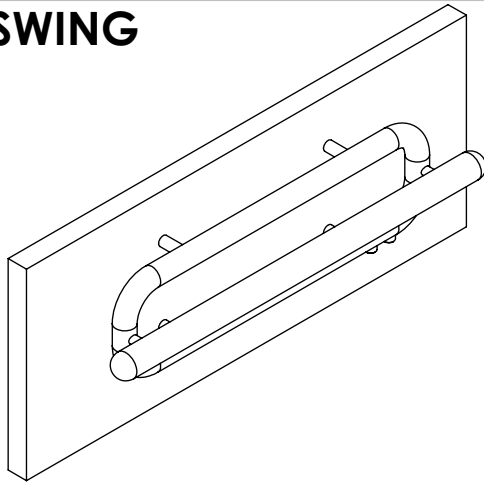

material	finish	electric version	wall installation	warranty
stainless steel	satin polished	not available	horizontal	10 years

max. working pressure: 10 bar  
 max. working temperature: 95°C  
 all dimensions are in mm.  
 connections 1/2"  
 middle connection available

Product Code	Width	Height	Depth	Connection Centers	Tube Quantity	Assembly Axis		Weight	Water Capacity	THERMAL POWER		
	W	H	D	C		S	L	kg.	lit.	btu	k/cal	watt
SW100002500109	1000	250	130	50	1	200	450	5,8	5,5	1233	311	361

# SWING



-  x4 Pieces
-  x1 Pieces
-  x4 Pieces
-  x8 Pieces
-  x1 Pieces
-  x1 Pieces

Product Code	Width	Height	Depth	Connection Centers	Tube Quantity	Assembly Axis		Weight	Water Capacity
	W	H	D	C		S	L	kg.	lit.
SWI100002500109	1000	250	130	50	1	200	450	5,8	5,5